



6X3 Oscar Shed Assembly Manual

Revision #7 JM
August 5, 2014

Thank you for purchasing our 6x3 Oscar Storage Shed. Please take the time to identify all the parts prior to assembly.

Please use Safety Eyewear and Gloves while Assembling. Be sure to read and follow all operating instructions for any tools used during assembly. Remember- NO SAW CUTTING IS REQUIRED!

Safety Points and Other Considerations

Our products are built for use based on proper installation and normal residential use, on level ground. Please follow the instruction manual when building your Oscar and retain the manual for future maintenance purposes.

-Some of the safety and usage measures you may wish to consider include:

- In high or gusty wind conditions it is advisable to keep the structure securely grounded.
- Have a regular maintenance plan to ensure screws, doors, roof and parts are tight.

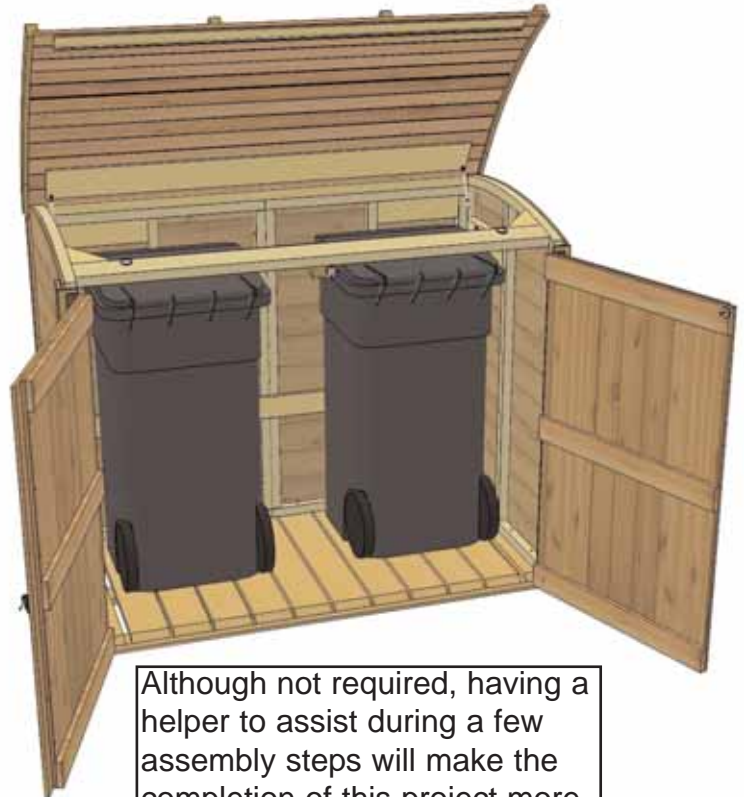

Although not required, having a helper to assist during a few assembly steps will make the completion of this project more convenient for you.

Assembly Video Instructions

To view the assembly video, click on the following link:
www.youtube.com/watch?v=1BapdJOpJoY

You can also view the assembly video via the QR Reader App on your smart phone.

If you don't have a QR Reader App on your smart phone, follow the steps below.

Go to your App Store and search for a QR Reader App and install.
Scan QR code to the right, it will direct you to YouTube where you can view the video.



6x3 Oscar Dimensions:

Inside - 32" d x 66 3/4" w x 50" (front) 53" (back)

Outside with Lid Overhang - 37" d x 72 5/8" w x 55" (front) 58" (back) Important - Inside distance in front between floor and underside of Front Top Plate = 50"

- Inside depth when Doors are closed to Rear Wall = 32"

Please check your garbage can height and depth to confirm they fit prior to purchasing and assembly.

In the event of a missing or broken piece, simply call the Outdoor Living Today Customer Support Line @ 1-888-658-1658 within 30 days of the delivery of your purchase. It is our commitment to you to courier replacement parts, free of charge, within 10 business days of this notification. Replacement parts will not be provided free of charge after the 30 day grace period.

Exploded View and Parts List for 6'x3' Oscar

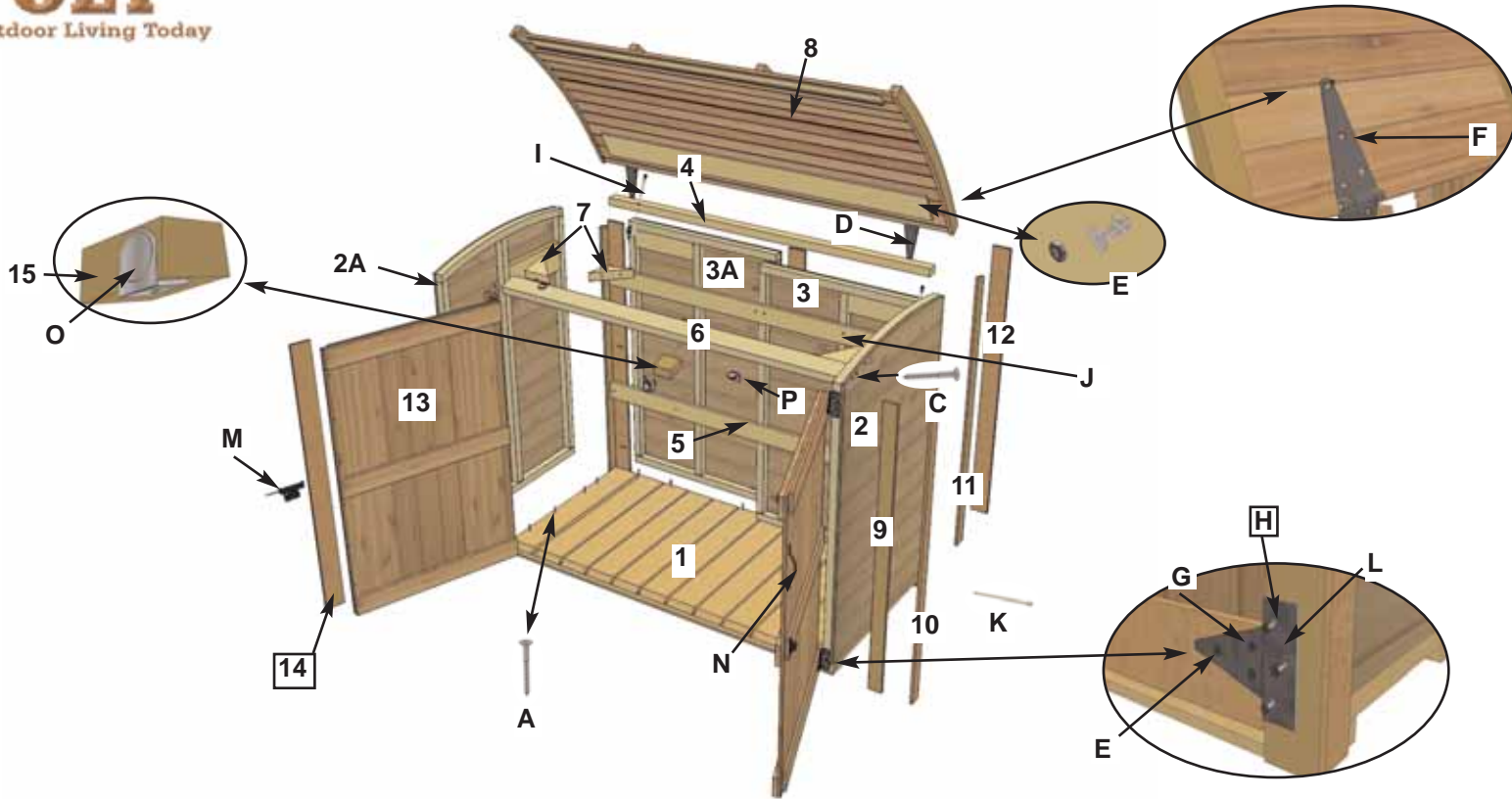

Parts Lists:

Floor and Walls

- 1 1 - Floor - 35" x 70 3/4" (45 degree angle cut on front edge)
- 2 1 - Right Side Wall - Arched Top - 35" x 52" (front) 53 1/4"(rear)
- 2A 1 - Left Side Wall - Arched Top - 35" x 52" (front) 53 1/4"(rear)
- 3 1 - Rear Wall (Right Side) - 33 3/8" x 52"
- 3A 1 - Rear Wall (Left Side) - 33 3/8" x 52"
- 4 1 - Rear Wall Top Cleat - 1 1/2" x 2" x 66 3/4"
- 5 2 - Rear Wall Cleats - 3/4" x 3 1/2" x 66 3/4"
- 6 1 - Front Top Plate - 1 1/2" x 3 1/2" x 66 3/4"
- 7 4 - Triangular Top Cleats - 1 1/2" x 5 1/2" x 5 1/2"

Lid

- 8 1 - Curved Lid - 37" x 72 5/8"

Trim

- 9 2 - Front Door / Corner Trims - 1/2" x 2 1/2" x 52"
- 10 1 - Front Left Side Corner Trim - Angle Cut Top - 1/2" x 2 1/2" x 53"
- 10A 1 - Front Right Side Corner Trim - Angle Cut Top - 1/2" x 2 1/2" x 53"
- 11 1 - Rear Left Side Corner Trim - Angle Cut Top - 1/2" x 2 1/2" x 54 1/4"
- 11A 1 - Rear Right Side Corner Trim - Angle Cut Top - 1/2" x 2 1/2" x 54 1/4"
- 12 3 - Rear Trim - 1/2" x 3 1/2" x 55"

Doors

- 13 2 - Doors - 32 3/4" x 50 1/2"
- 14 1 Door Flange - 1/2" x 3 1/2" x 50 1/2"
- 15 1 Door Stop - 1 1/2" x 3 1/2" x 4" (12 degree cut on 1 end)

Hardware Packs (3 Clear Plastic Bags R, R1 & R2) (See Page 3 for illustrated Hardware Details)

R includes:

- A 2 1/2" Brown Screws (46)
- B Square Drive Bit (1)
- C 3" Brown Screws (9)
- E 2" Black Bolt (Head Only) with Silver Washer and Nut (6)
- F 1" Black Screws (10)
- G 3/4" Black Screws (32)
- H 2" Black Head Screws (16)
- J 1 1/4" Brown Screws (28)
- K 1 1/2" SS Finishing Nails (60)

R1 includes:

- D Black Strap Hinges (2)
- L Black Door Hinges (4)
- M Black Barrel Bolt (1)
- N Black Door Handles (2)
- O Door Magnet with mounting screws (1)
- P Lid Magnet with mounting screws (2)

R1 includes:

- I Gas Shocks with mounting hardware (2)

**Note: All Trim pieces are graded best face rough.
This means the rough side will be exposed when completing these Sections.**

6x3 Oscar Storage Shed

Hardware Kit (Provided)

Note: screws and nails shown actual size.

3/4"  Black
Part G x 32 pcs

1 1/2" 
Part K x 60 pcs

Part B Square Drive Bit x 1 pc

3" 
Part C x 9 pcs

2 1/2" 
Part A x 46 pcs

2"  Black
Part H x 16 pcs

2" 
Part E x 6 pcs

1 1/4" 
Part J x 28 pcs

1"  Black
Part F x 10 pcs



Part D - Black Strap Hinge x 2 pcs



Part L - Tee Hinge x 4 pcs



Part M - Barrel Bolt x 1 pc



Part N - Door Handles x 2 pcs



Part I - Gas Shocks x 2 pc



Part O - Door Magnet x 1 pc (Bent on angle) with Screws
Part P - Lid Magnet x 2 pcs (90 degree bend) with Screws

Tools Required (Not Provided)



Hammer



Screw Gun/Drill



Tape Measure



Wood Clamp



Level



Pliers



3/8" Wrench or Socket



1/8" Drill Bit

Safety Equipment Required (Not Provided)



Safety Glasses



Work Gloves

Before assembling your Oscar, be sure to lay down a foundation for your unit to sit level on.

There are many options such as patio paving stones, a concrete slab or fine crushed gravel.

Make sure the area is level and not elevated with surrounding ground so garbage cans can move easily in and out of your Oscar.

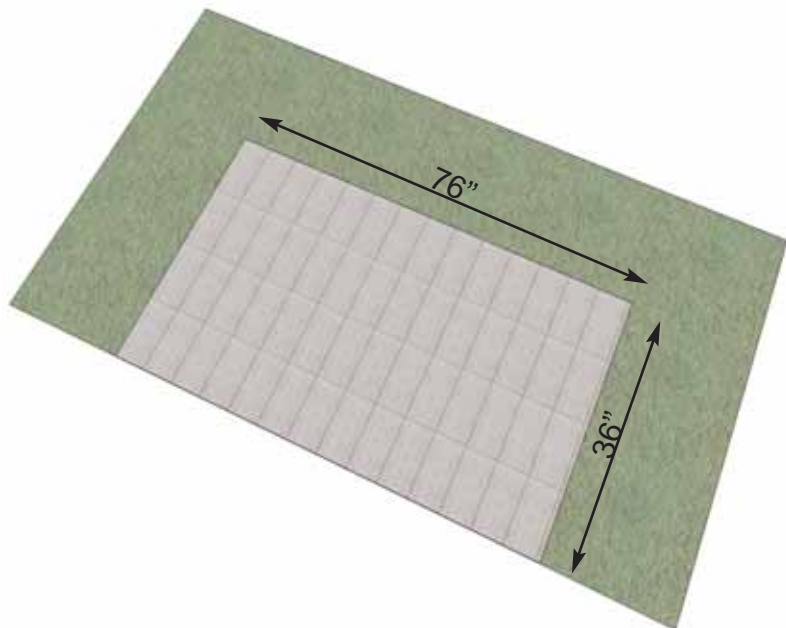

**Important -
Make sure foundation is level
before moving on to Floor and Wall
Sections. Use a level to confirm.**

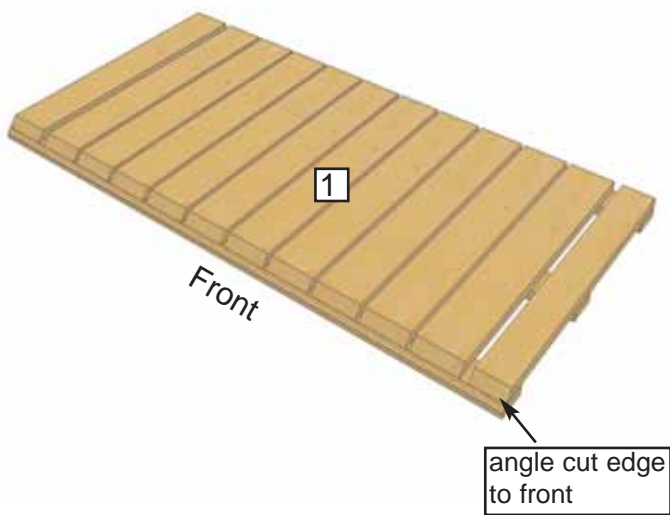

1. Locate **Floor (1)** and lay down on level foundation. Place floor with angle cut edge to the front. Level floor if required.

2. Identify all Wall Panels;
2 - Side Wall Arched Panels (2 & 2A) Left/Right and
2 - Rear Wall Panels (3 & 3A) Left/Right

If you have space, position walls around floor leaving enough room to work. Make sure walls are correctly orientated. Avoid positioning rear walls upside down. Check orientation with side wall siding to confirm. **The thick butt of the siding is down.**

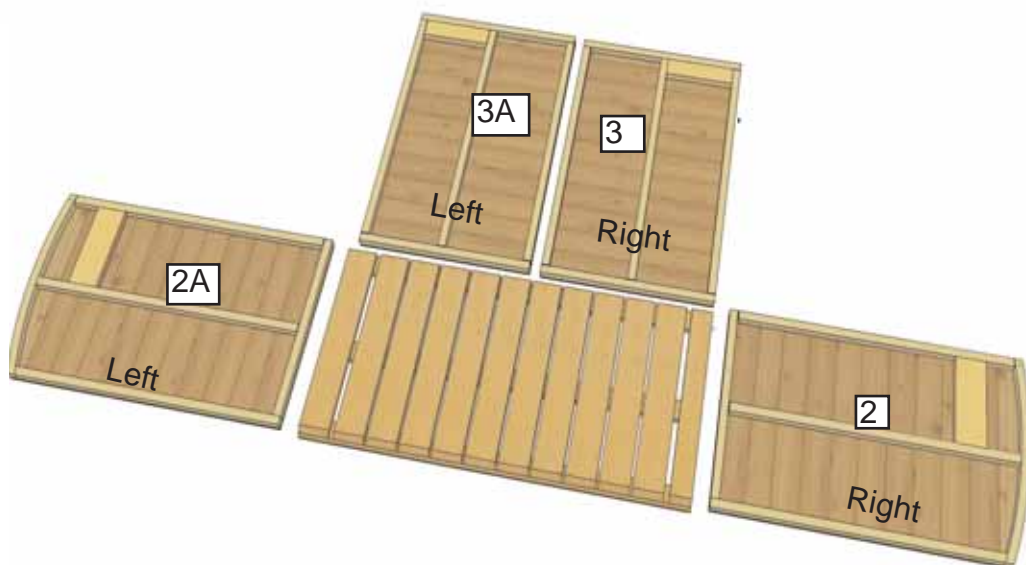

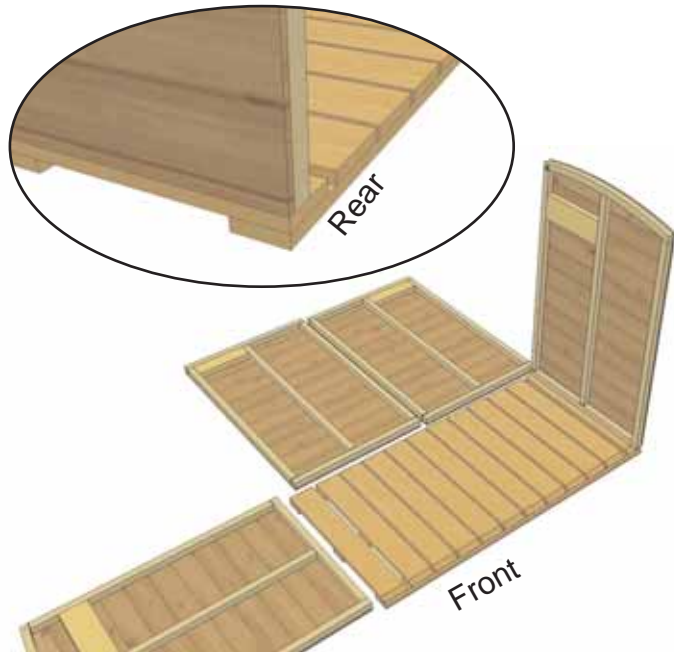

3. Lift Side Wall (2) up and orientate so wall framing is flush at rear with floor, wall siding is flush on side with floor. In the front, wall framing will overhang the floor as shown below.

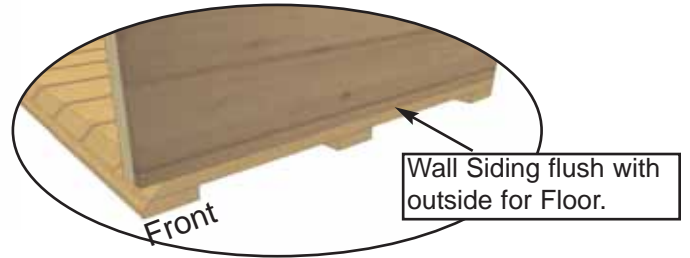

4. Lift up a Rear Wall (3) and orientate the wall as shown above. At the bottom, align wall siding even with outside of the floor. At the top, align wall siding flush with framing of side wall. When correctly aligned, attach wall frames together with **3 - 2 1/2" screws (A)**. Screw on a slight angle to penetrate the side wall framing best.

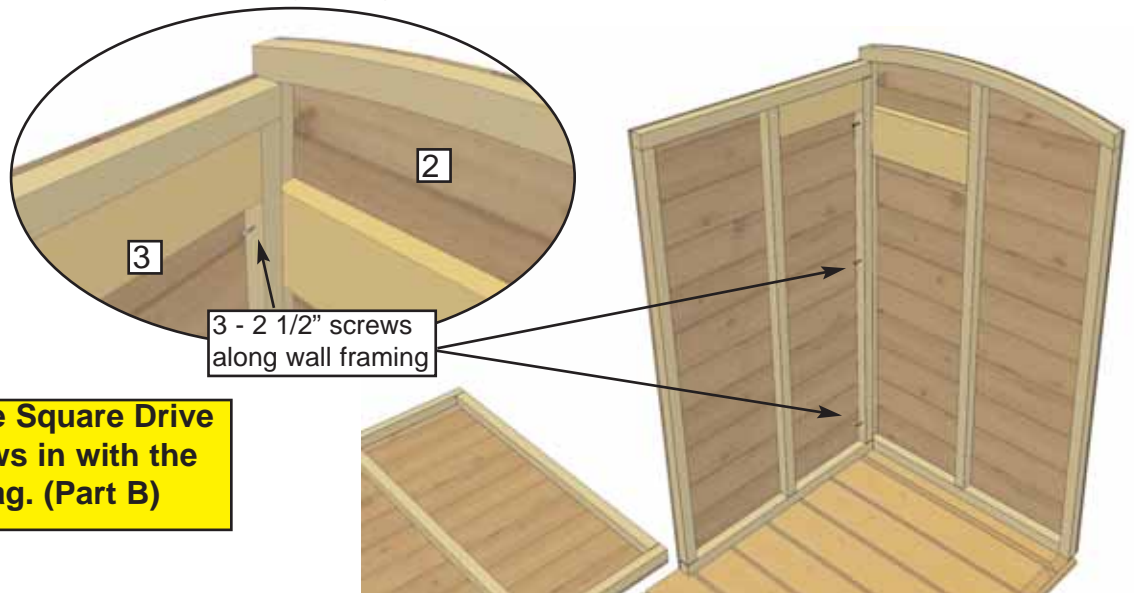

You can find the Square Drive Bit for the screws in with the Hardware Kit Bag. (Part B)

5. Position and attach 2nd Rear Wall (3A). Align rear wall frames together and attach with **3 - 2 1/2" screws (A).**

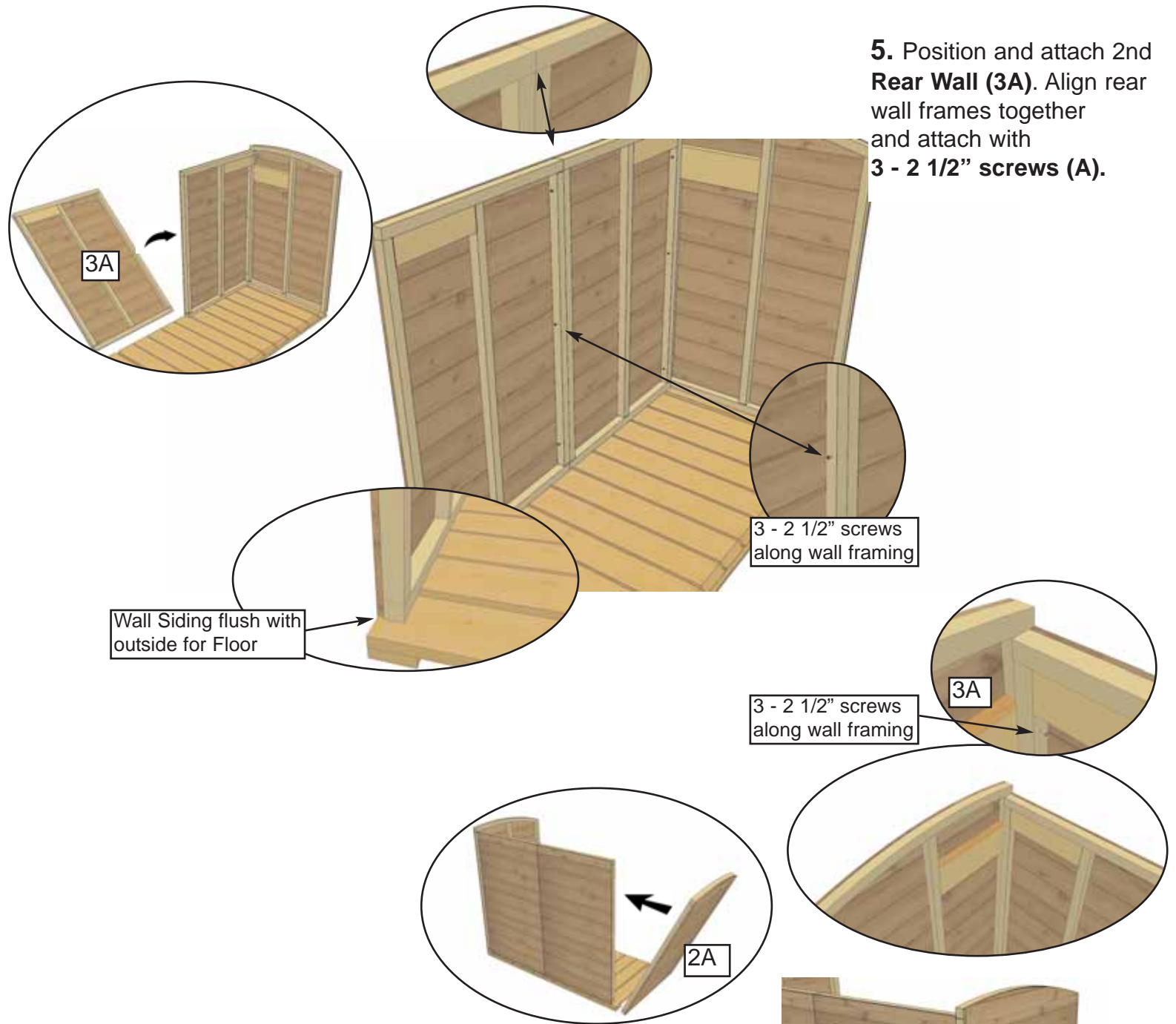

6. Lift 2nd Side Wall (2A) up and orientate and attach wall to rear wall framing as per Step 3 and 4.



7. Check for wall/floor alignment (wall siding flush with outside of floor on sides and rear). When satisfied, secure wall framing to floor with **4 - 2 1/2" screws (A)** per wall panel.

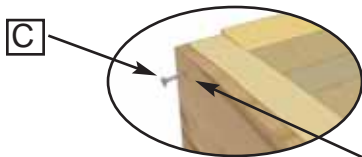
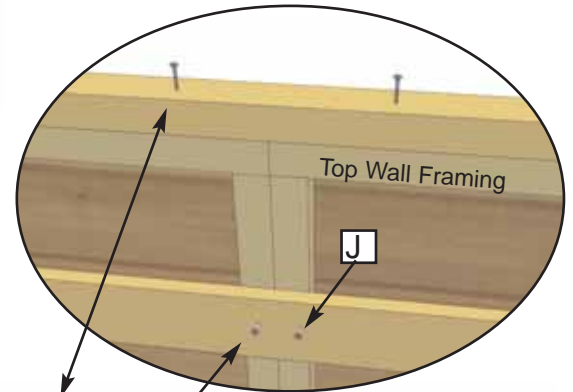
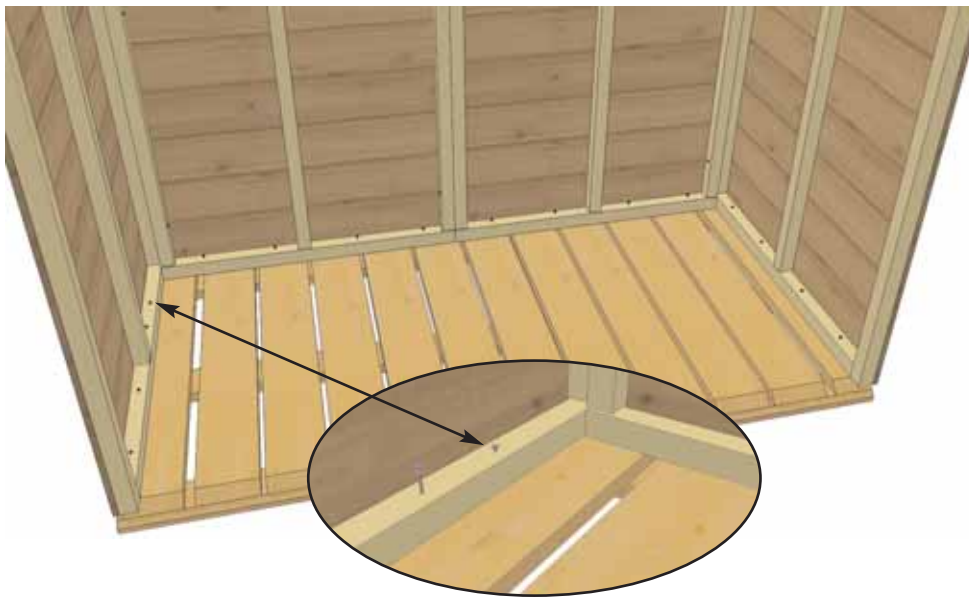

8. Locate Rear Wall Top Cleat (4). Center rear wall top cleat on top wall framing. Attach with **6 - 2 1/2" screws (A)** down into framing. From side walls, locate pre-drilled hole at top rear and attach side wall to top cleat with **1 - 3" screw per side (C)**.

Place both **Rear Wall Cleats (5)** against wall frames and attach each cleat with **6 - 1 1/4" screws (J)** into wall framing. We recommend locating one wall cleat 18" from bottom and the other 18" higher.

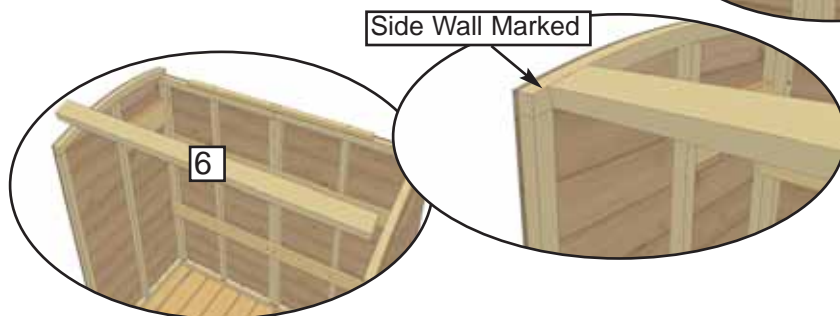
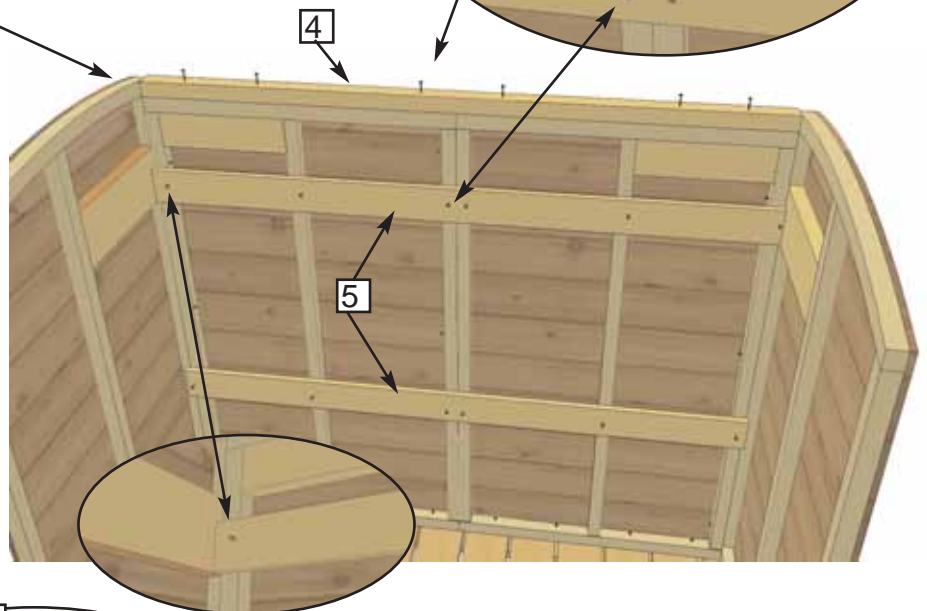

9. Place Front Top Plate (6) between side walls at top front. Side walls will be marked for plate alignment on the inside framing. With you helpers holding one end, secure opposite end with **2 - 3" screws (C)**. Side walls are pre-drilled. Complete both ends.

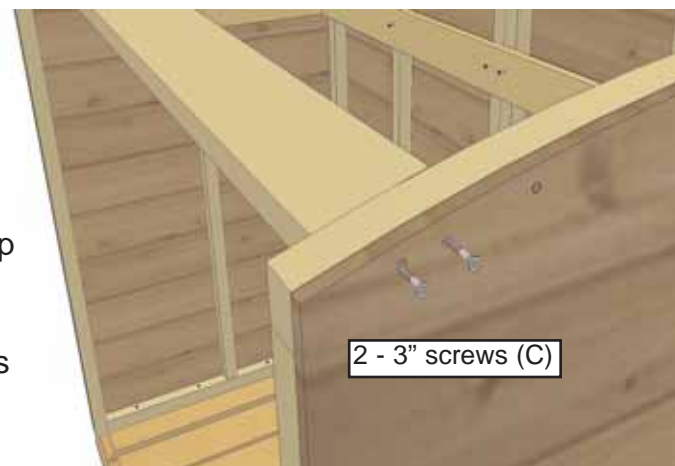

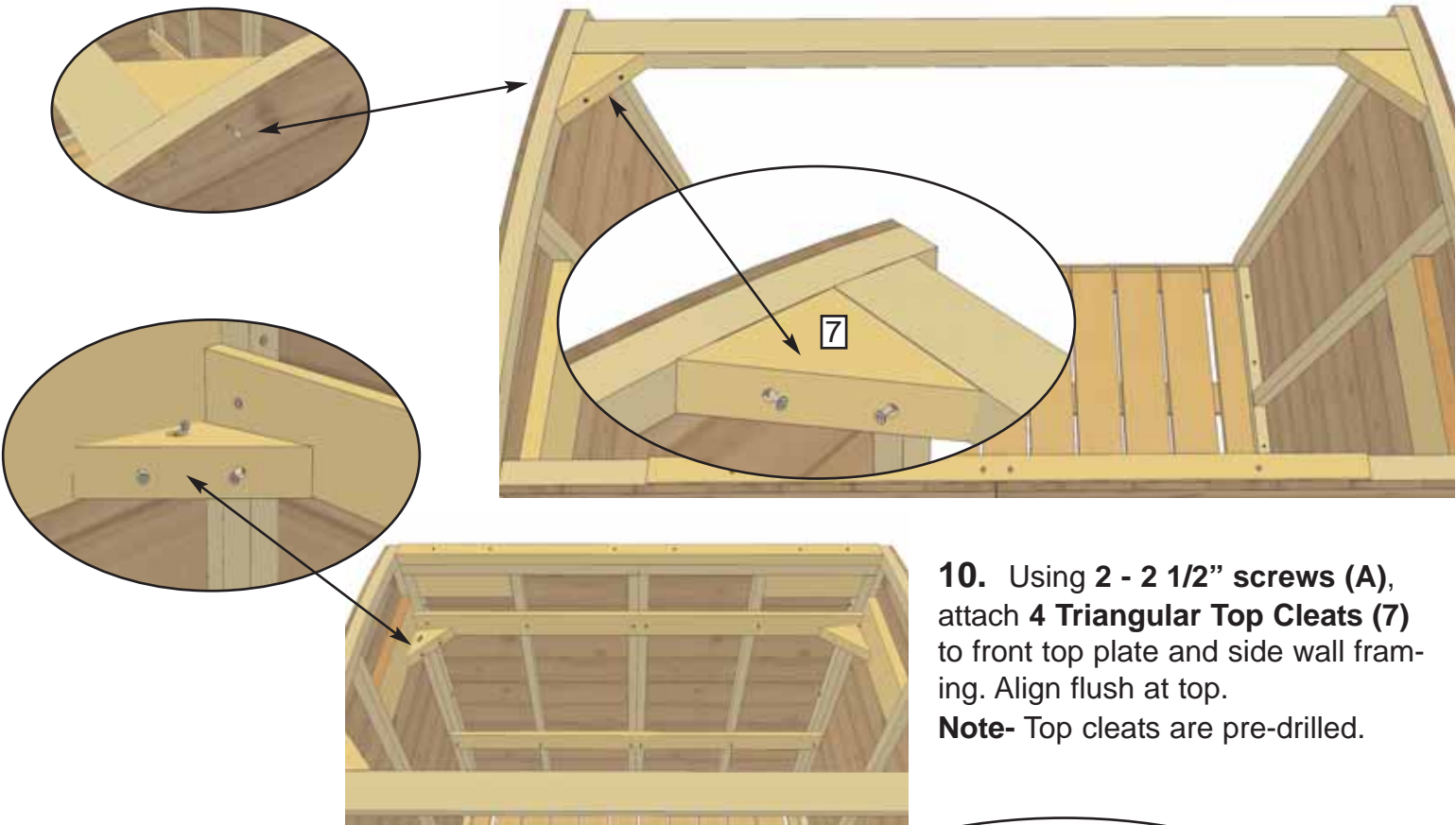

10. Using 2 - 2 1/2" screws (A), attach 4 Triangular Top Cleats (7) to front top plate and side wall framing. Align flush at top.

Note- Top cleats are pre-drilled.

11. With your helper, lift and position the Curved Lid (8) on top of wall framing. Center on walls from front to rear and evenly from side-to-side.

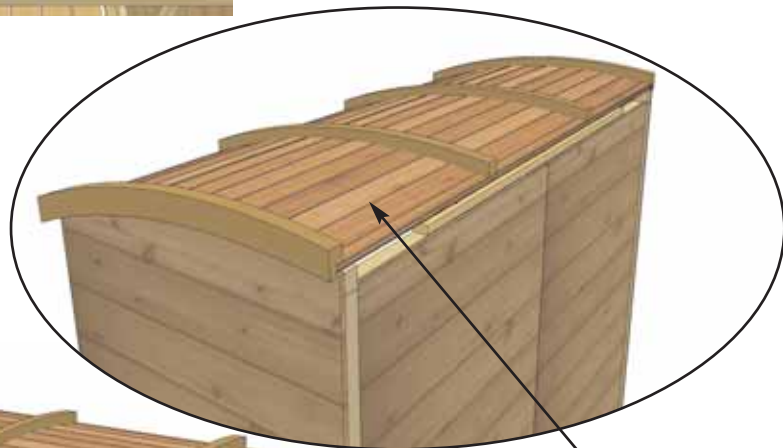
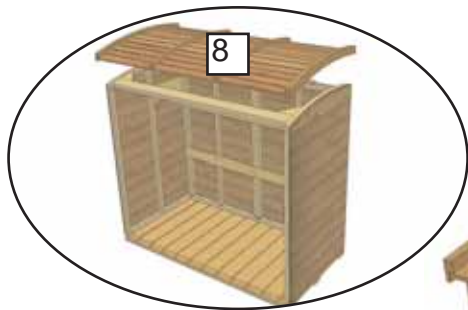

Lid has pre-drilled hole at rear to help identify orientation.

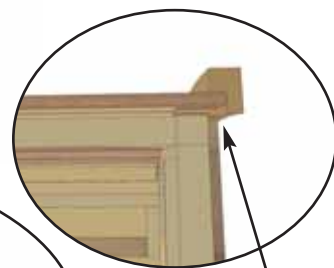
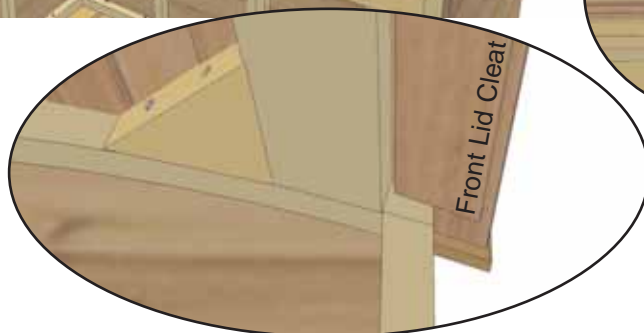

Evenly spaced from side-to-side

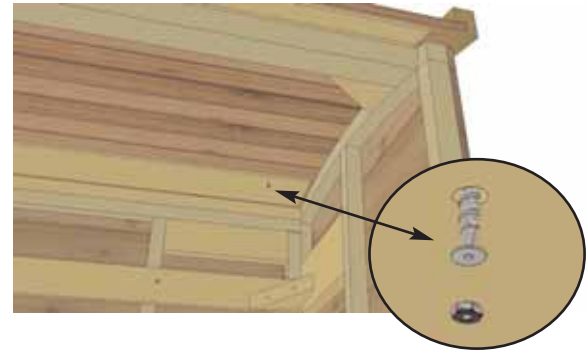
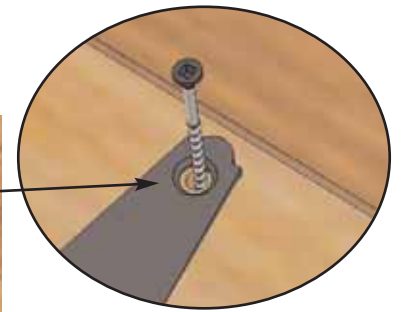
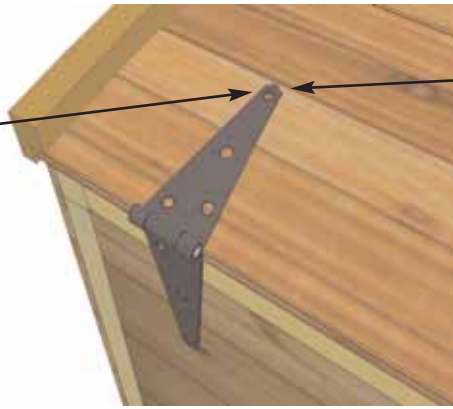
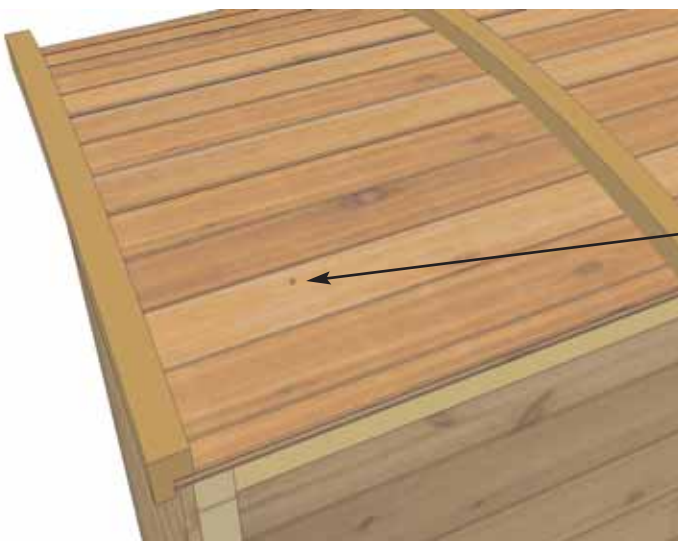

12. Locate both **Rear Black Strap Hinges (D)**. Orientate hinge as shown to right so pre-drilled hole in lid and top hinge hole align. Slide in a **2" Black Bolt with Washer and Nut (E)** through hinge hole and lid. From the inside, slide **Washer** on and tighten **Nut** snug with 3/8" socket or wrench. Complete both sides.

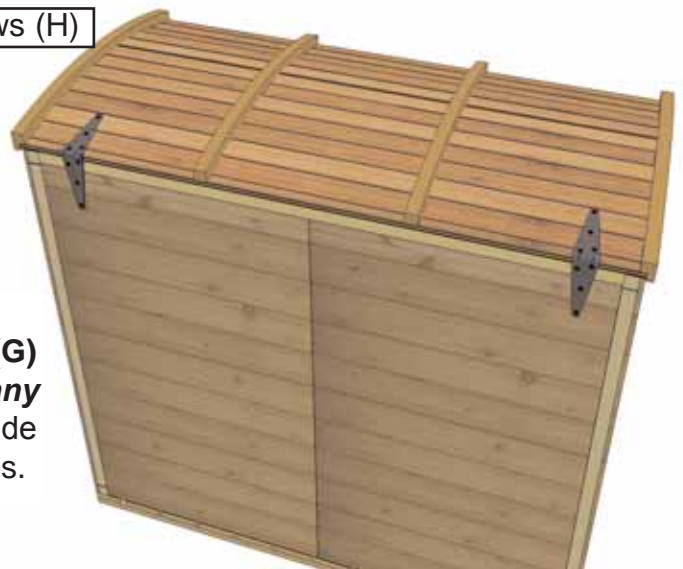
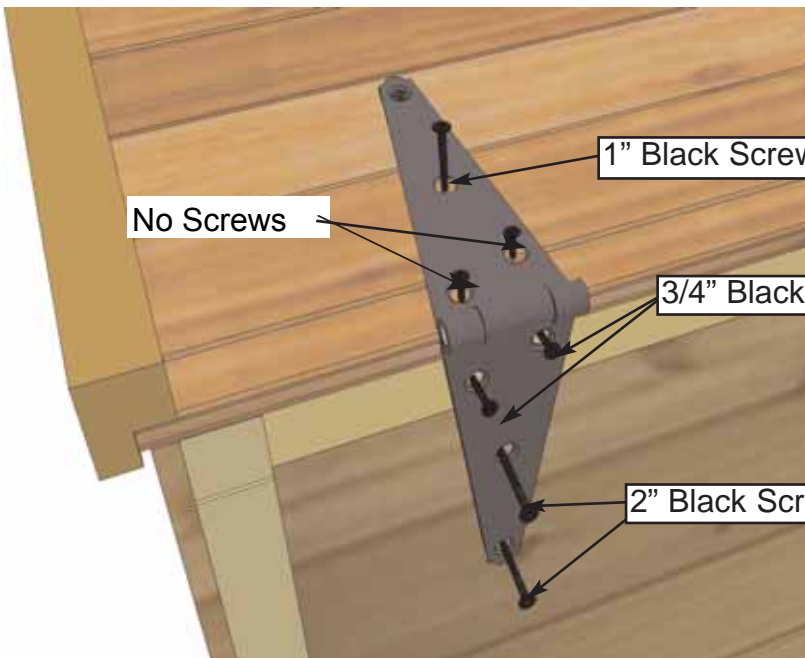

13. Complete Strap Hinge attachment using **1 - 1" Black Screw (F)** and **2 - 3/4" Black Screws (G)** on the lid side. *On the top wall side do not install any screws, leave the holes empty.* On the lower wall side install **2 - 2" Black Screws (H)**. Complete both sides.



Important: Have your assistant hold Lid open to desired height while Gas Shocks are attached. Never close Lid with only 1 Gas Shock attached. This may cause damage to shock and Lid. Some adjustment to height and depth of bottom of shock may be necessary to achieve optimum Lid opening height. Gas Shock is shipped with piston extended. Piston can only be closed when both Shocks are attached correctly to lid.

14. Have your helper hold lid open high enough to desired height while both **Gas Shocks (I)** are installed. To establish approximate shock position, center top shock attachment on rear lid cleat. Bottom shock flange will position against wall support. The bottom of the shock can be positioned on the wall support closer to the front or nearer to the back walls depending on what your desired lid height is.

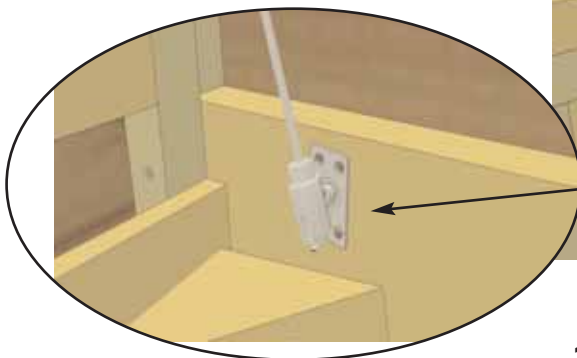
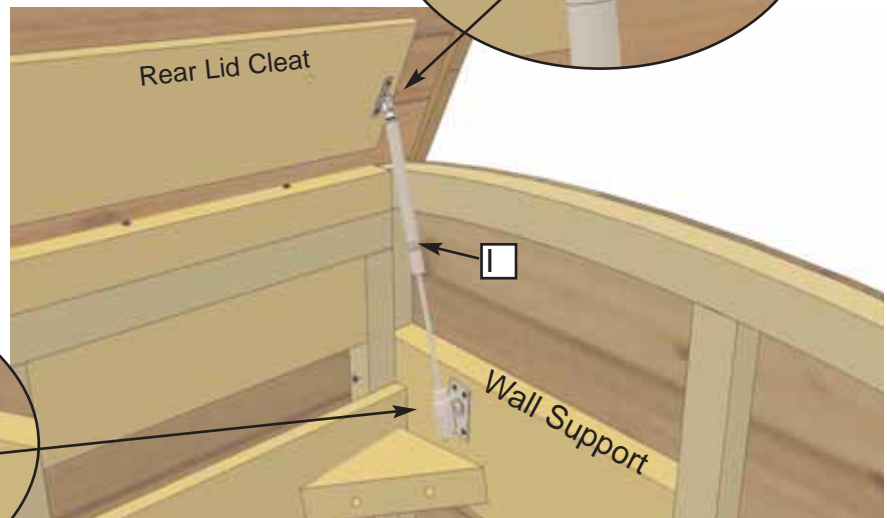
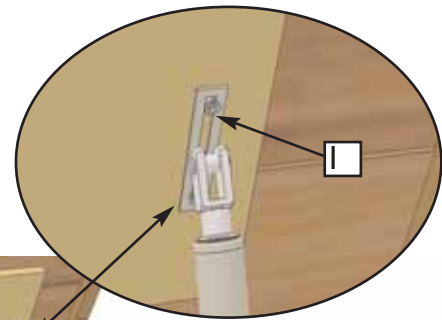
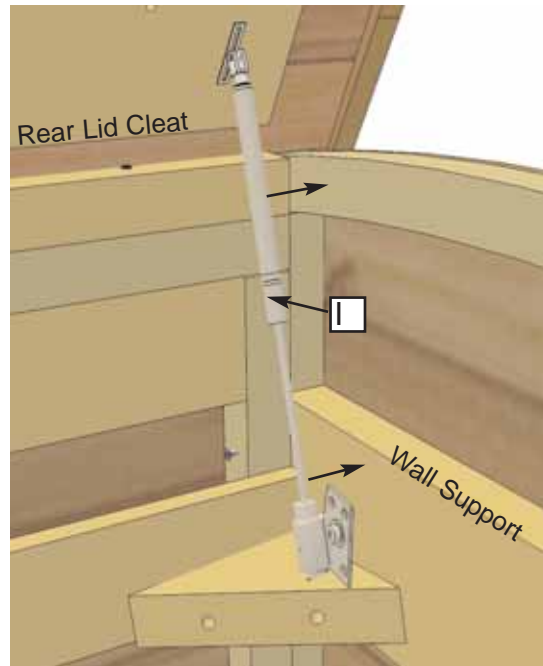

Important: Gas Shocks will be fully extended when initially installing.
Attach both Gas Shocks before attempting to close Lid.

15. Starting at the top, attach the gas shock to the lid cleat with **2 - 1 1/4" screws (J)**. Pre-drill lid cleat with **1/8" drill bit** to prevent wood from splitting, Attach bottom of gas shock to side wall Support with **4 - 1 1/4" screws (J)**.

Note: All Trim pieces are graded best face rough. Parts 10 & 10A & 11 & 11A are unique to each side. The rough side of all the trim will be the exposed face when nailing the pieces to the shed.

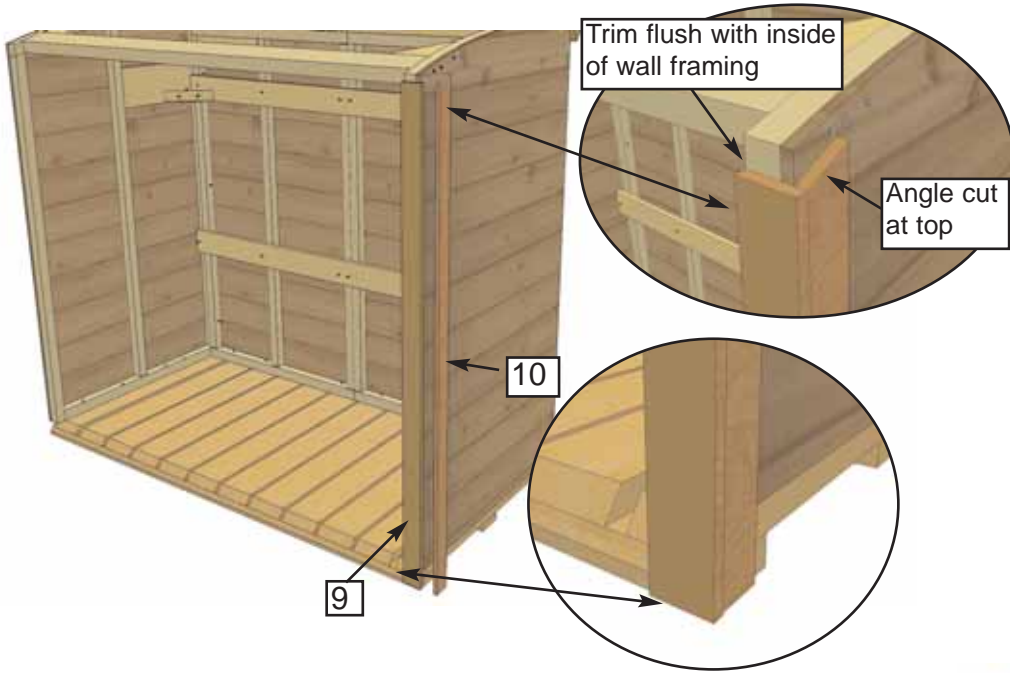

16. Close lid and mark the highest point **Front Corner Trims (9 & 9A)** 1/2" x 2 1/2" x 52" and **Front Side Corner Trim (10 & 10A)** with angle cut top 1/2" x 2 1/2" x 53" can be located without impeding the lid. Front trim should be positioned even with inside of wall framing. Attach each piece with **6 - 1 1/2" Finishing Nails (K)**.

Note: Part 9 will cap Part 10.

17. Position and attach **Rear Side Corner Trims (11 & 11A)** 1/2" x 2 1/2" x 54 1/4" and **Rear Trim (12)** 1/2" x 3 1/2" x 55". Align trims at top of wall panels without impeding the closing of the lid. Attach each piece with **6 - 1 1/2" Finishing Nails (K)**.

Note: Part 12 will cap Part 11.

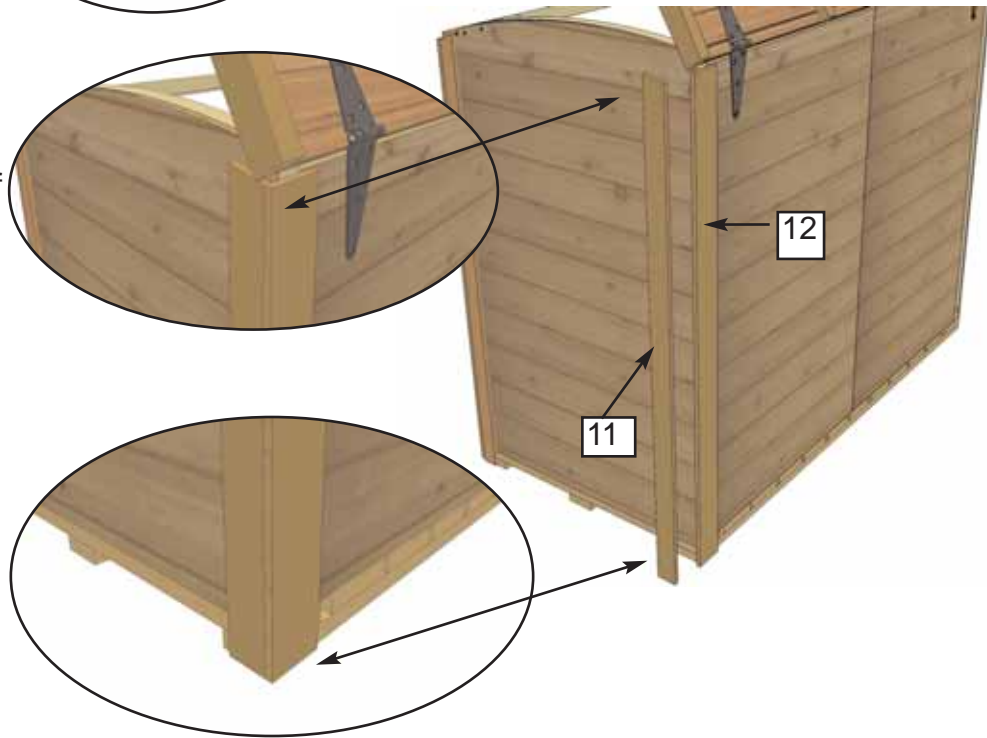

18. Center **Rear Trim (12)** 1/2" x 3 1/2" x 53" on rear wall seam and attach with **6 - 1 1/2" Finishing Nails (K)**. Align to same height and corner rear trims.

Important: Pilot Hole Door with 1/8" drill bit to prevent splitting!

19. Locate both **Doors (13)** and **4 Black T - Hinges (L)**. Lay Doors on flat ground with door trim recessed to center. Doors are pre-drilled in outside corners to accept **1 - 2" Black Bolt with Nut and Washer. (E)**

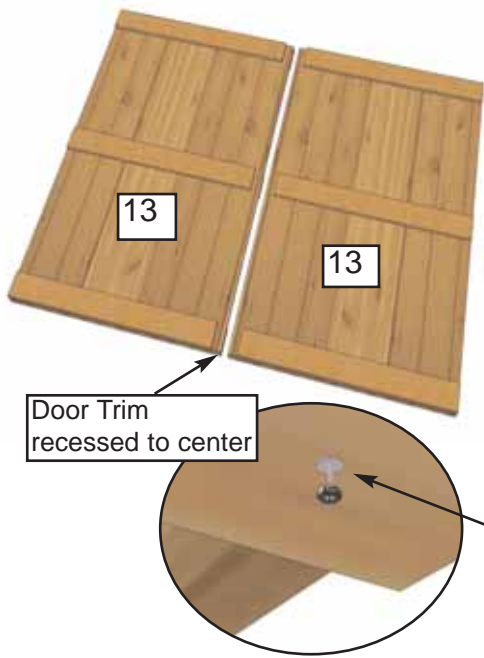

20. Line up pre-drilled holes in hinge and door and slide bolt through. Tighten bolt using 3/8" socket or wrench. Finish hinge by securing with **2 - 3/4" Black Screws (G)**. Drill shallow depth pilot holes first to prevent wood from splitting. Complete both doors (4 hinges).

21. Lift up a door and position so there is a 1/8" gap between front door corner trim and outside of door. Position door vertically so top of door aligns with top of front door corner trim. When door is aligned correctly, screw hinge into trim with **3 - 2" Black Screws (H)**. Use only 1 screw initially per hinge until both door alignments are confirmed. **Door Flange (14)**, attached in **Step 22** will cover gap between doors.

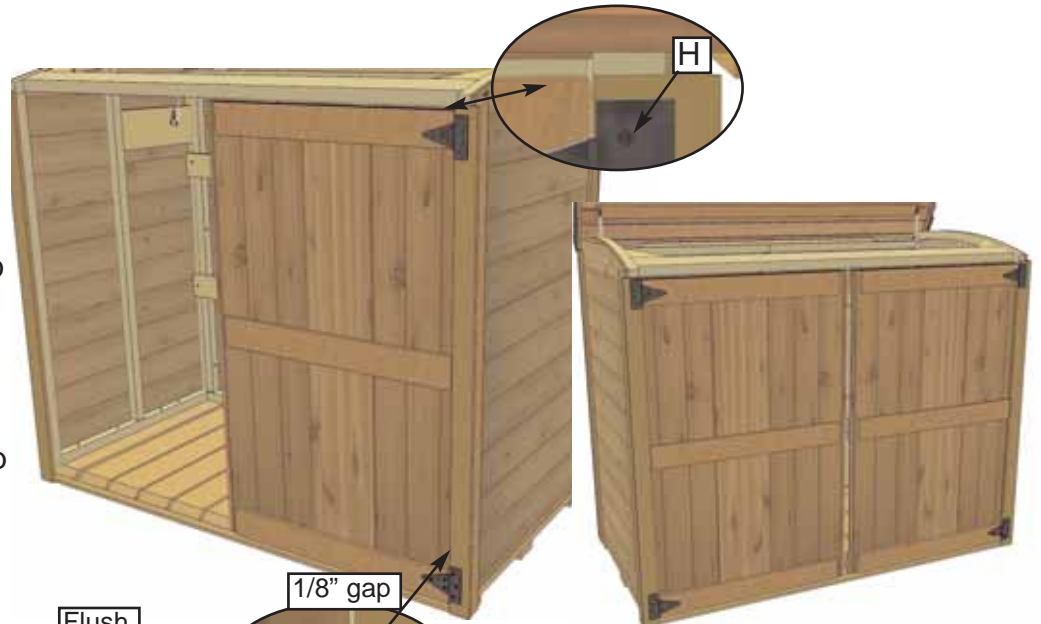

Drill 1/8" pilot holes for 2" screws to prevent wood from splitting.

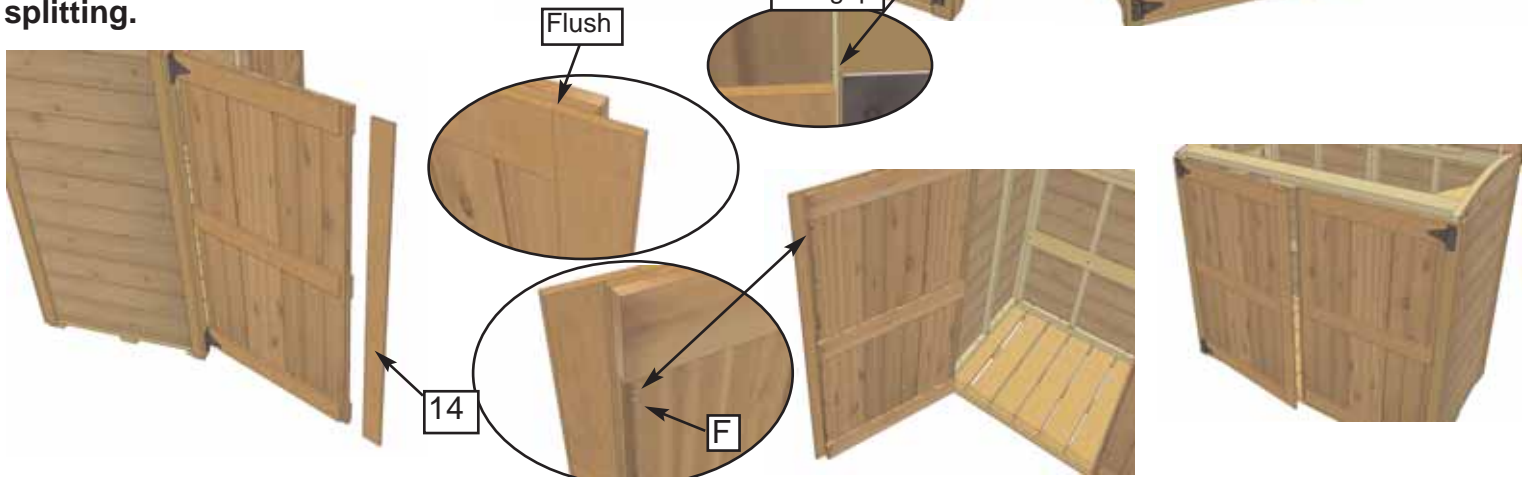

22. Locate **Door Flange (14)** - 1/2" x 3 1/2" x 50 1/2". Align tight and flush at top against horizontal door trim. Clamp flange to door or lay door on ground and have helper hold Flange in place and then screw together. Attach with **6 - 1" Black Screws (F)** evenly spaced on flange.



23. Position and attach **Black Barrel Bolt (M)** with **6 - 3/4" Black Screws (G)**. **Note** how female part of barrel bolt is positioned higher than male. Do a dry run first to position barrel bolt correctly. **Important** - Drill shallow pilot holes with 1/8" drill bit prior to securing with screws to prevent wood from splitting. Attach **2 Door Handles (N)** with **4 - 3/4" Black Screws (G)** per handle. Drill shallow pilot holes to prevent wood from splitting.

24. Center **Door Stop (15)** on underside of front top plate. Orientate door stop with angle cut end facing to the outside and flush with edge of top plate. Attach with **2 - 2 1/2" screws (A)**.

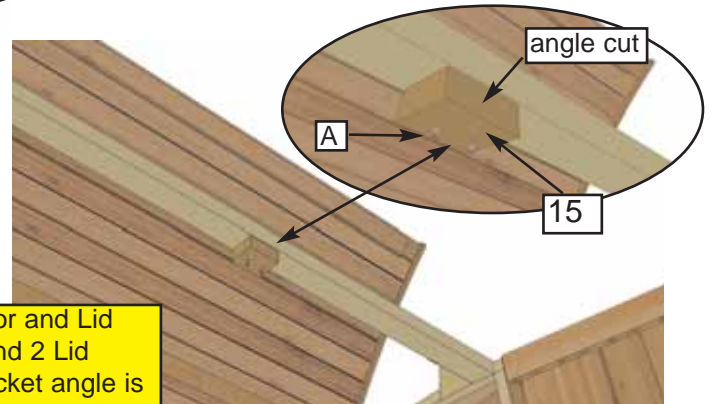

Magnets are used to keep the Door and Lid closed. There is 1 Door Magnet and 2 Lid Magnets. The Door Magnet's bracket angle is bent and the package will already be open.



25. Before securing **Door Magnet (O)**, do a dry run by closing door on door stop and mark spot for magnets. When satisfied with location, secure magnets to door stop and door with hardware found in magnet package.

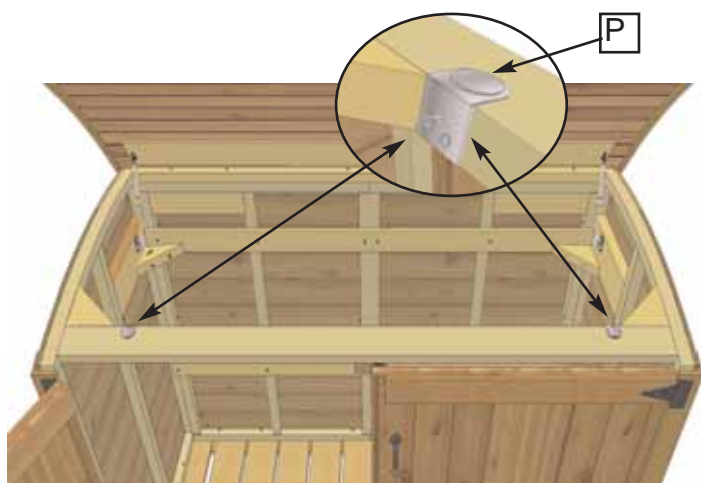
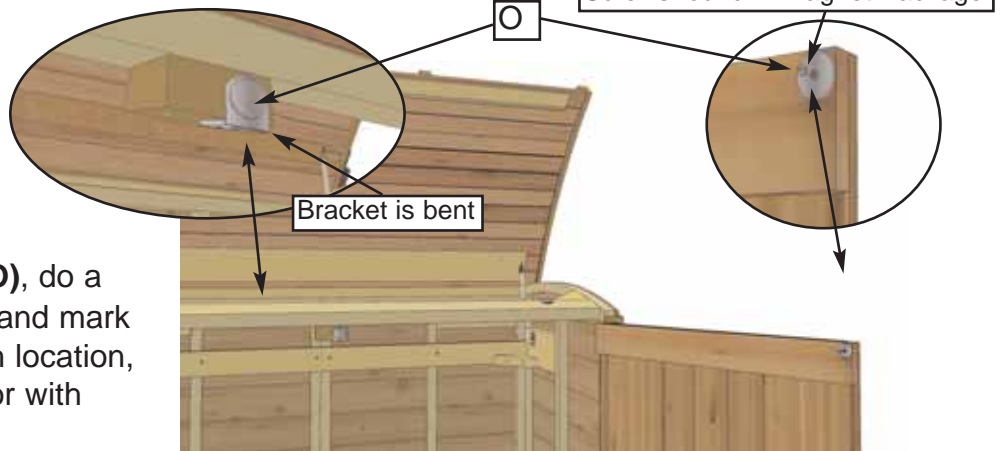

Close Lid and mark

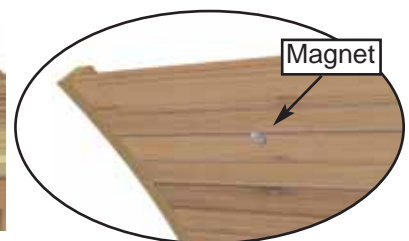

26. To complete, position and attach both **Lid Magnets (P)** to top of front top plate and to the underside of the lid. Start by attaching magnet bracket to inside edge of top plate with magnet screws. Close lid and mark location on the underside of the lid. Try using duct tape (sticky side up) on bracket magnet to help with alignment. Attach to lid with magnet screws.

Note; Our Sheds are shipped as an unfinished product. If exposed to the elements, the western red cedar lumber will weather to a silvery-gray color. If you prefer to keep the cedar lumber looking closer to the original color, we suggest that you treat the wood with a good oil base wood stain. You may also wish to paint your new shed rather than stain it. In both cases we recommend that you consult with a paint and stain dealer in your area for their recommendations.



Congratulations on assembling your 6x3 Oscar Storage Shed!

We hope your experience constructing our **6x3 Oscar** has been both positive and rewarding. We value your feedback and would like to hear back from you on how well we are doing in the following areas:

1. **Customer Service**
2. **On Time Shipping**
3. **Motor Freight Delivery**
4. **Quality of Materials**
5. **Assembly Manual**
6. **Overall Satisfaction.**



Please call, write or email us at:

Outdoor Living Today

Canadian Address
9393 287th Street

Maple Ridge, British Columbia
Canada V2W 1L1

United States Address
P.O. Box 96

Sumas, Washington
USA 98295

The materials contained in this Assembly Manual may be downloaded or copied provided that ALL copies retain the copyright and any other proprietary notices contained on the materials. No material may be modified, edited or taken out of context such that its use creates a false or misleading statement or impression as to the positions, statements or actions.